



Lift and slide balcony door

MB-77HS

The **MB-77HS** "Lift & Slide" door product is an ideal solution for connecting interior space rooms or conservatories with the outside balcony, terrace or garden area. Providing both a smooth & silent slide action operation, it can bring the benefits of a beautiful day outside, into the living space. In addition, & by way of its design & operation, the **MB-77HS** is a great space saving opening & does not encroach the free space beyond the internal or external confines of the frame, without any compromise. Providing excellent weather tightness together with enhanced thermal performance, the **MB-77HS** complies with all of the requirements associated with this product type. Available in two different options, with regard to the level of thermal performance, the **MB-77HS** is further categorised as "ST" and "HI," standard or highly insulated. The design & arrangement of the system profiles enable luxurious openings of large dimensions, accommodating double & even triple glass unit compositions, which in conjunction with the constituent parts & innovative technical solutions, help achieve a high level of thermal & acoustic performance.

▪ *brings the outdoors inside*

▪ *excellent weather performance*



CONSTRUCTION VARIANTS

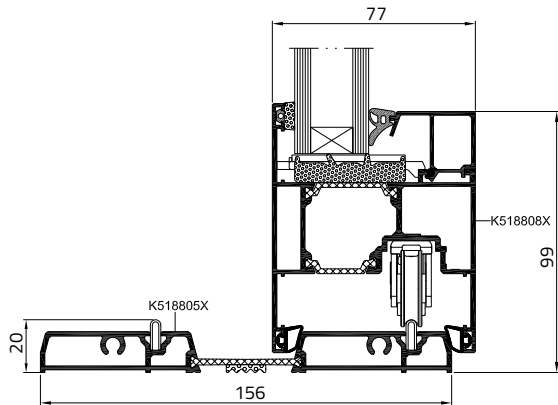

MB-77HS ST - low doorsill variant

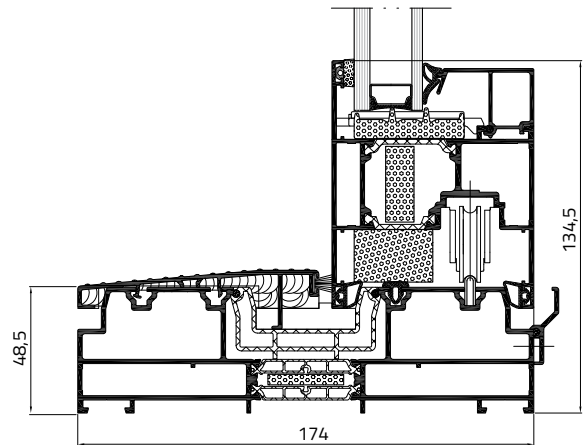

MB-77HS HI

AVAILABLE DOOR CONSTRUCTION

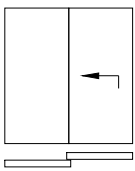

Scheme A

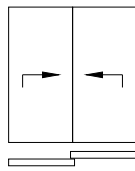

Scheme D

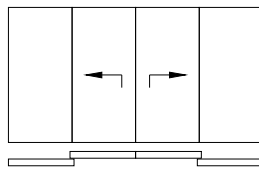

Scheme C

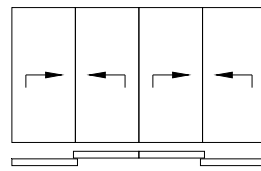

Scheme F

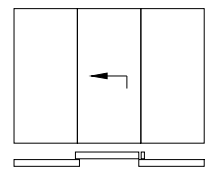

Scheme G2

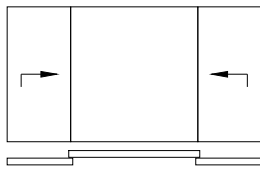

Scheme K

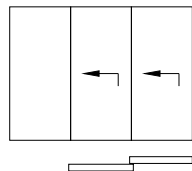

Scheme A+G

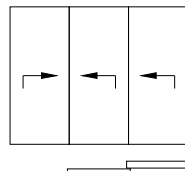

Scheme D+G

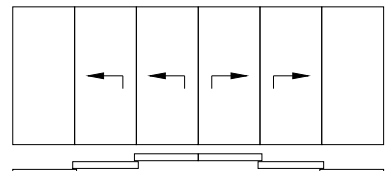

Scheme C+G+G

EXAMPLES OF CONSTRUCTIONS

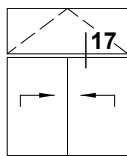

top fanlight option

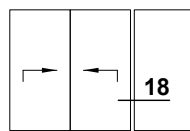

fixed sidelight option

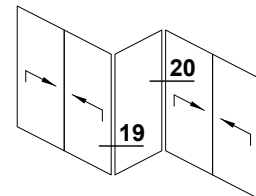

internal/external corner solutions

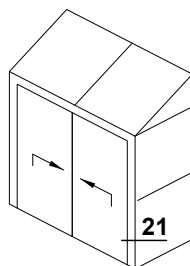

build into MB-WG60 conservatory system

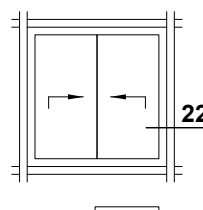

build into a curtain walling system

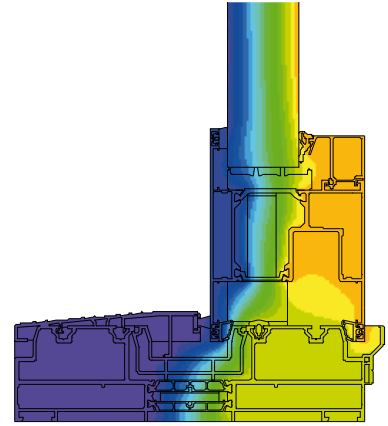

distribution of isotherms in the MB-77HS HI door

RAL palette varnishes



Special finishes ATEC



Wood grain ADEC

ADEC D101 golden oak



ADEC O102 walnut



ADEC M103 mahogany



ADEC M204 mahogany sapeli



ADEC O205 walnut vein



ADEC S106 pine

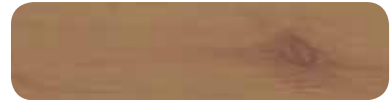

ADEC J107 fir



ADEC B108 beech



ADEC W109 cherry



ADEC W205 wenge



ADEC D207 winchester



ADEC C110 gean



ADEC C212 gean





FEATURES AND BENEFITS

- durable and slender profiles enable screens of a low-threshold door of the weight of the leaf of up to 400 kg, height – up to 3.2 m and width - up to 3,3 m
- a wide range of glazing options, allowing application of double or triple glazed units combined with thermal breaks as well as additional inserts, enable achieving high thermal and acoustic insulation of the door.
- for aesthetic values glazing beads come in three options: Standard (rectangular), Prestige (rounded) and Style (shaped)
- closed shape of glazing beads and anti-jemmy details provide enhanced security properties without altering any essential constructional elements of the door
- unique gasket designs, together with quality hardware, ensure top end weather and air tightness performance
- profiles adapted to accommodate a number of manually or automatically operated hardware available on the market
- possibility to drive the doors with automatic "HS-Master" mechanism controlled with a push-button or remote control
- safe use of even large and heavy doors thanks to "HS Speed Limiter" mechanism available in the system
- a large degree of compatibility with the MB-86 system creates an aesthetic combination of the MB-77HS doors with windows, and using the same components in the fabrication process
- a wide range of colour schemes allows for arrangement of doors to meet any individual requirements

TECHNICAL SPECIFICATION	MB-77HS ST / MB-77HS HI
Depth of frame	174 mm (2-rail profile), 271 mm (3-rail profile)
Depth of leaf	77 mm
Glazing rang	13,5 – 58,5 mm
MIN VISIBLE WIDTH T-PROFILE	
Frame	48 mm
Leaf	94,5 – 105,5 mm

PERFORMANCE	MB-77HS ST / MB-77HS HI
Air Permeability	class 4, EN 12207
Watertightness	class 9A, EN 12208
Windload resistance	to class C4, EN 12210
Thermal insulation	U_f from 1,4 W/(m ² K), U_w from 0,84 W/(m ² K)*

* - U_w for MB-77HS HI doors with 3,0 × 2,9 m leaf, and glazing of $U_g=0,5$ W/(m²K) equipped with a Chromatech Ultra spacer.