

1 ENTRY DOOR HEAD DETAIL
DG-ALU79-1 SCALE: 1:2

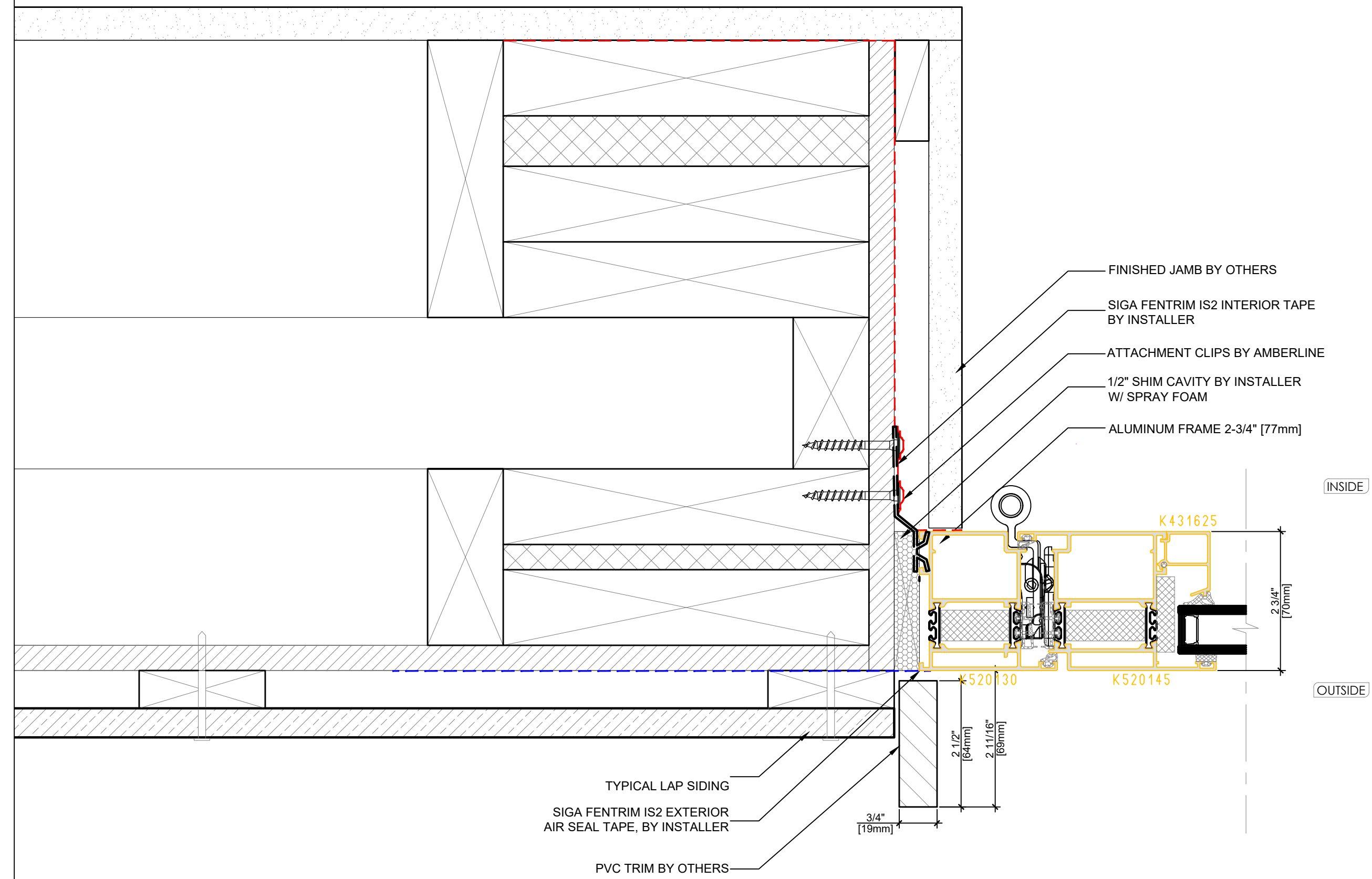

3 ENTRY DOOR JAMB DETAIL
DG-ALU79-1 SCALE: 1:2

Elevation key:

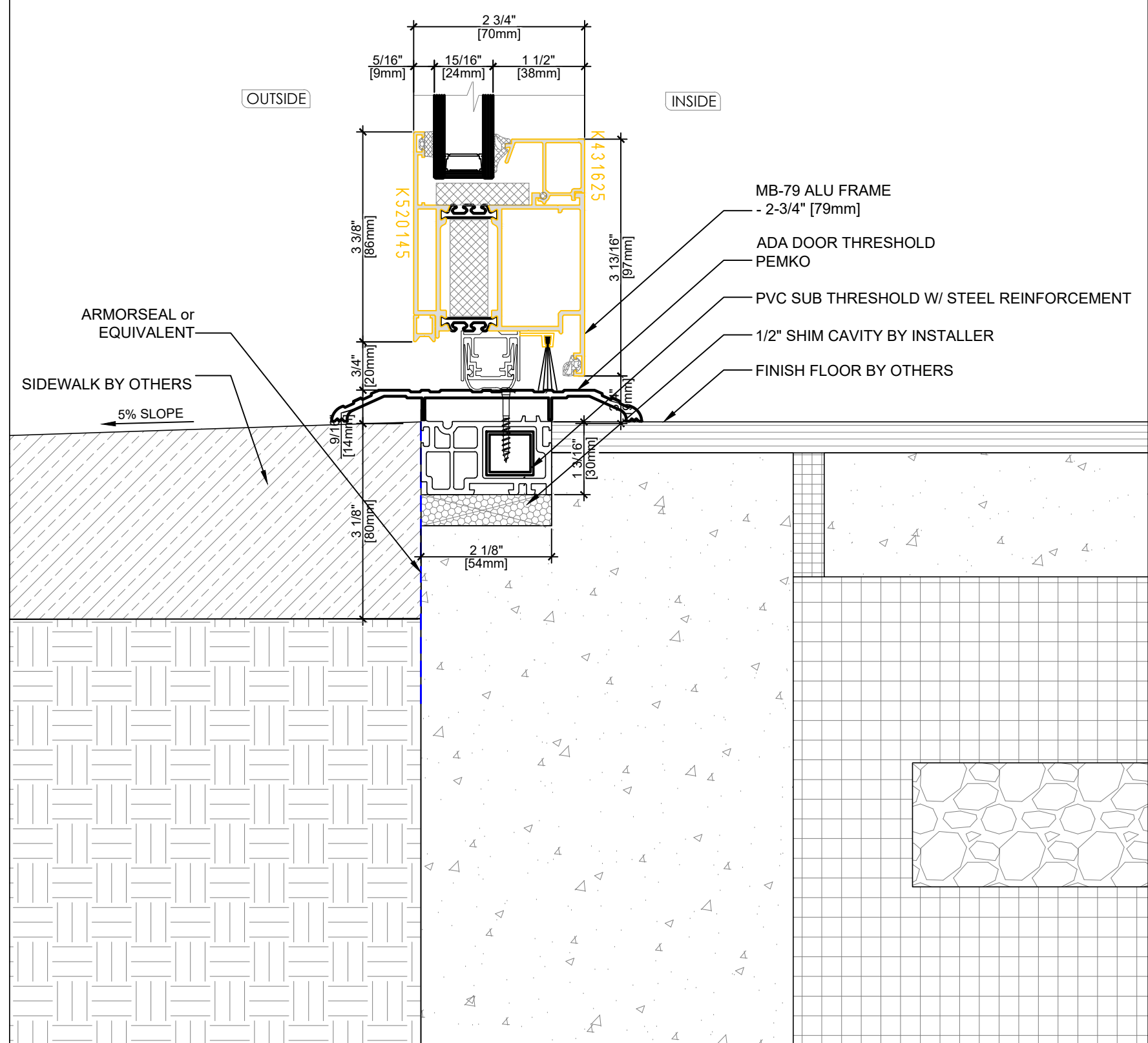
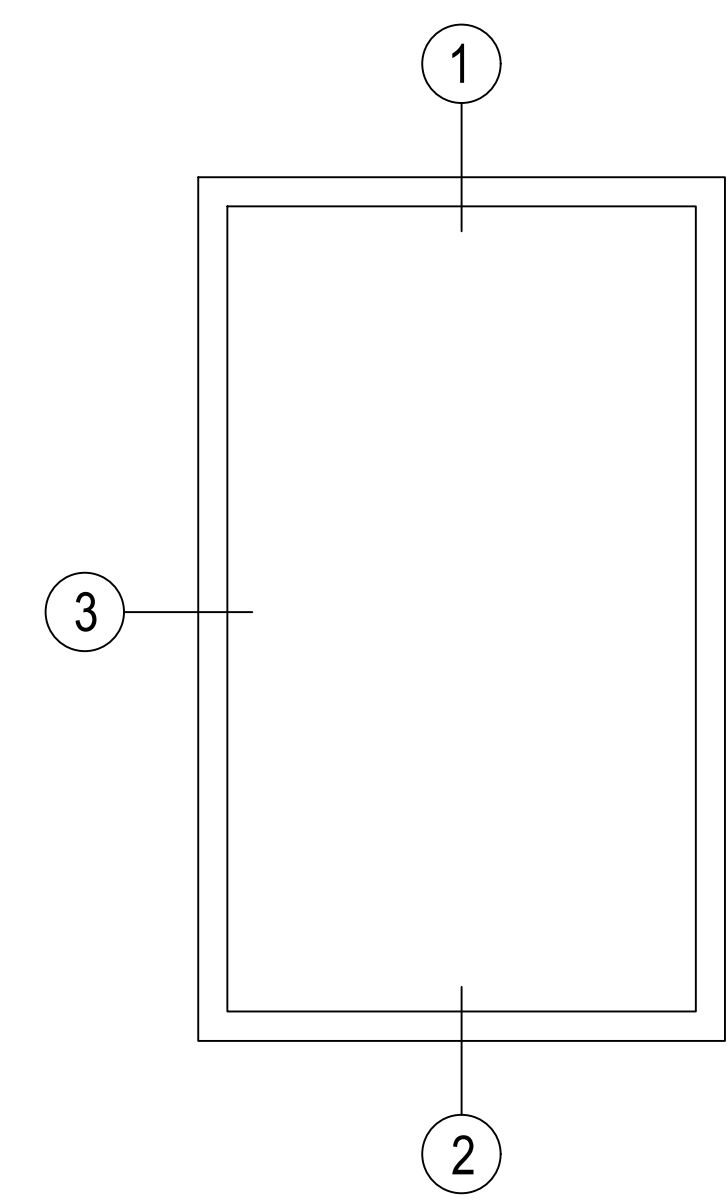

2A Option A:
ADA ENTRY DOOR SILL DETAIL
DG-ALU79-1 SCALE: 1:2 Complies with MA CMR 521

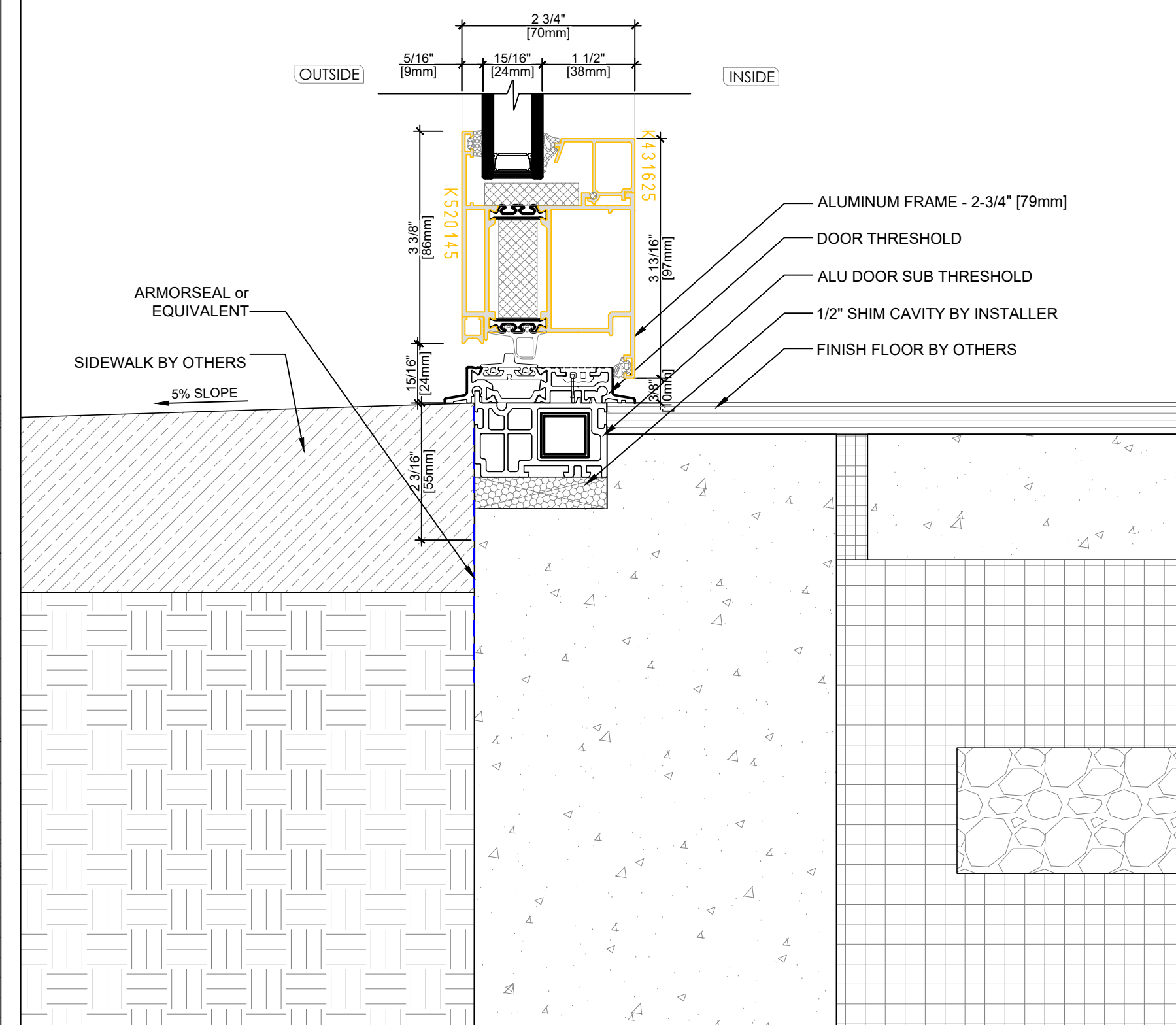

2B Option B:
ENTRY DOOR SILL DETAIL
DG-ALU79-1 SCALE: 1:2

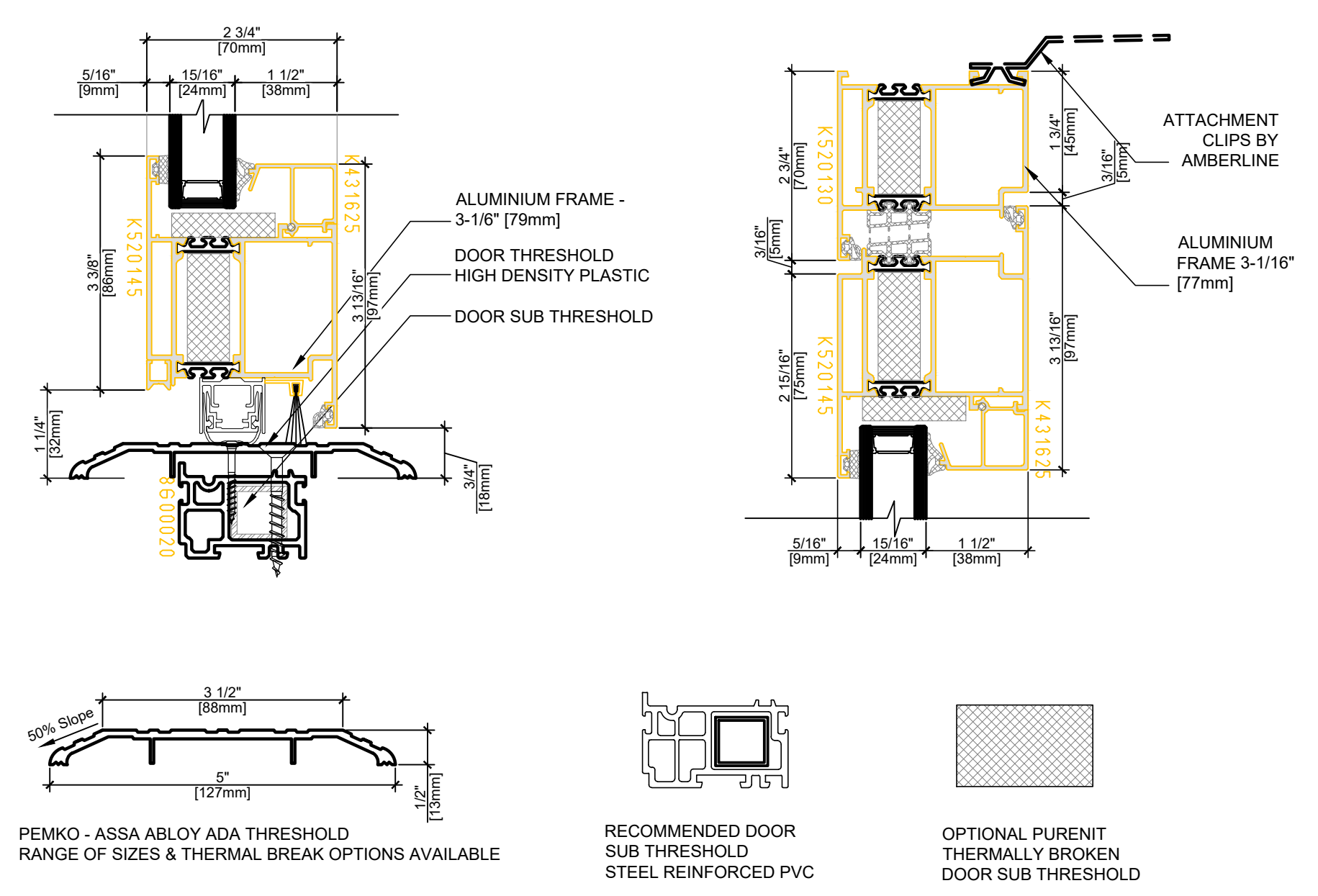

4 PROVIDED BY AMBERLINE
DG-ALU79-1 SCALE: 1:2

AMBERLINE
HIGH PERFORMANCE WINDOWS AND DOORS

Notes:

Detail Type : Design Guide	
Drawing Title : ALU 79_ADA Door_Concrete	
Date : 07/24/24	Scale : 1 : 2
Drawn By : RP	Scale : 1 : 2
Drawing No : DG-ALU79-1	

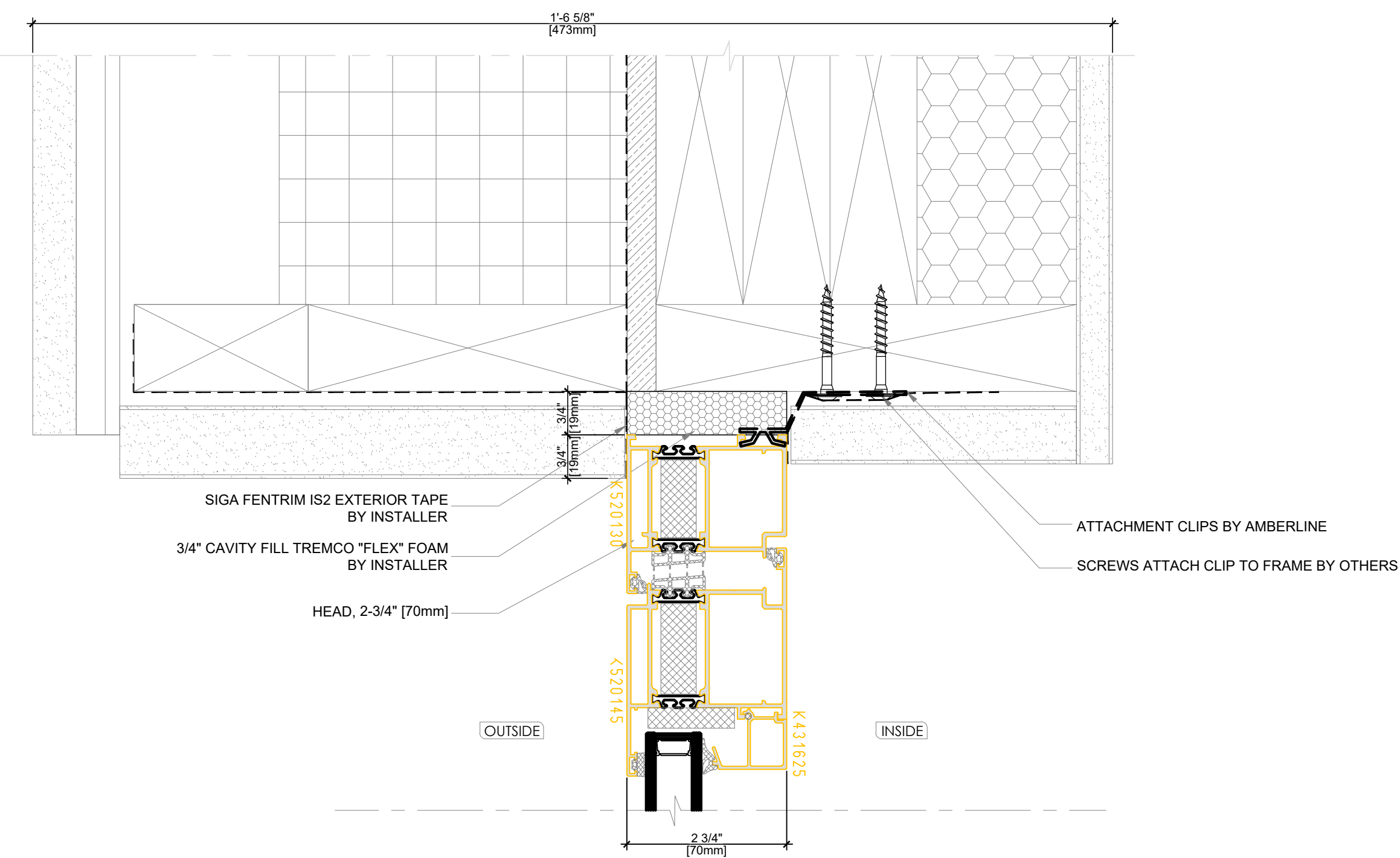

1 ENTRY DOOR HEAD DETAIL
DG-ALU79 -2 SCALE: 1:2

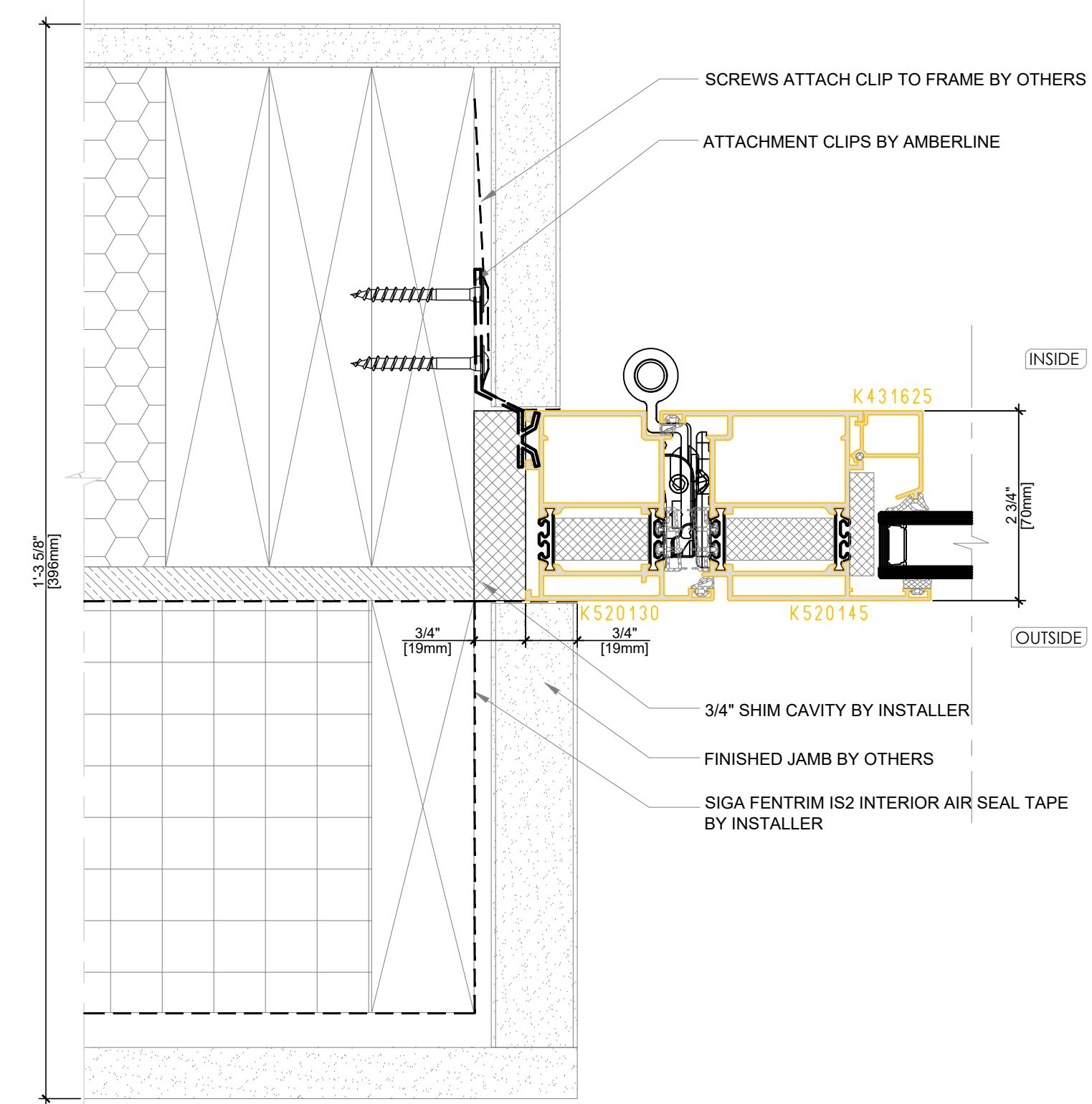

3 ENTRY DOOR JAMB DETAIL
DG-ALU79 -2 SCALE: 1:2

Elevation key:

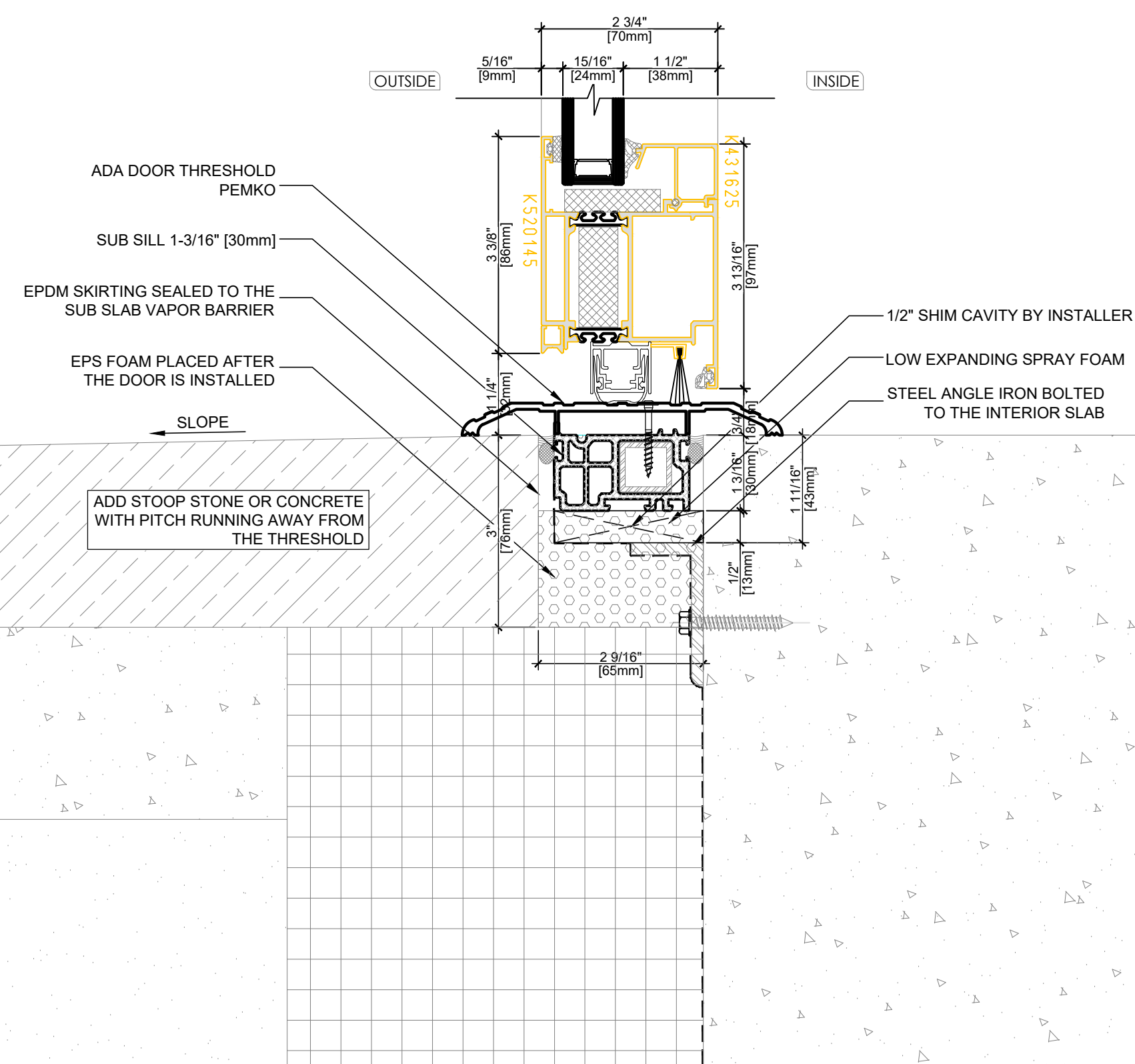
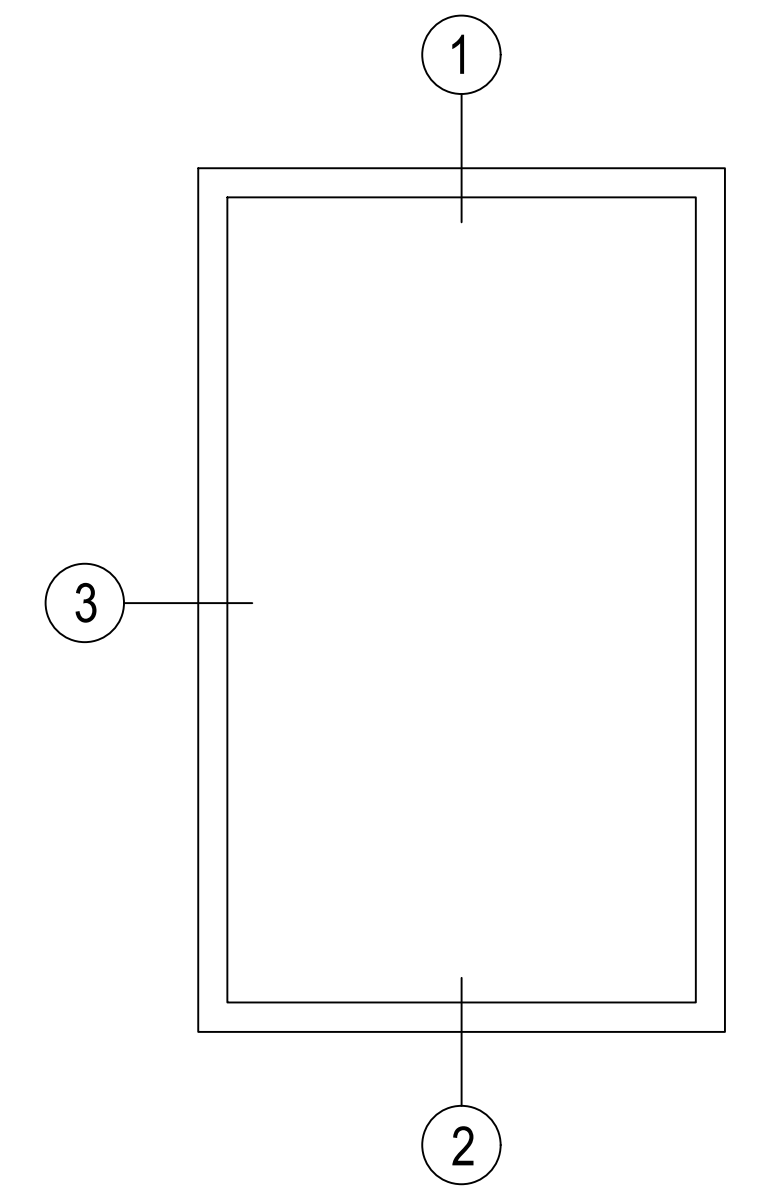

2A Option A:
ADA ENTRY DOOR SILL DETAIL
DG-ALU79 -2 SCALE: 1:2 Complies with MA CMR 521

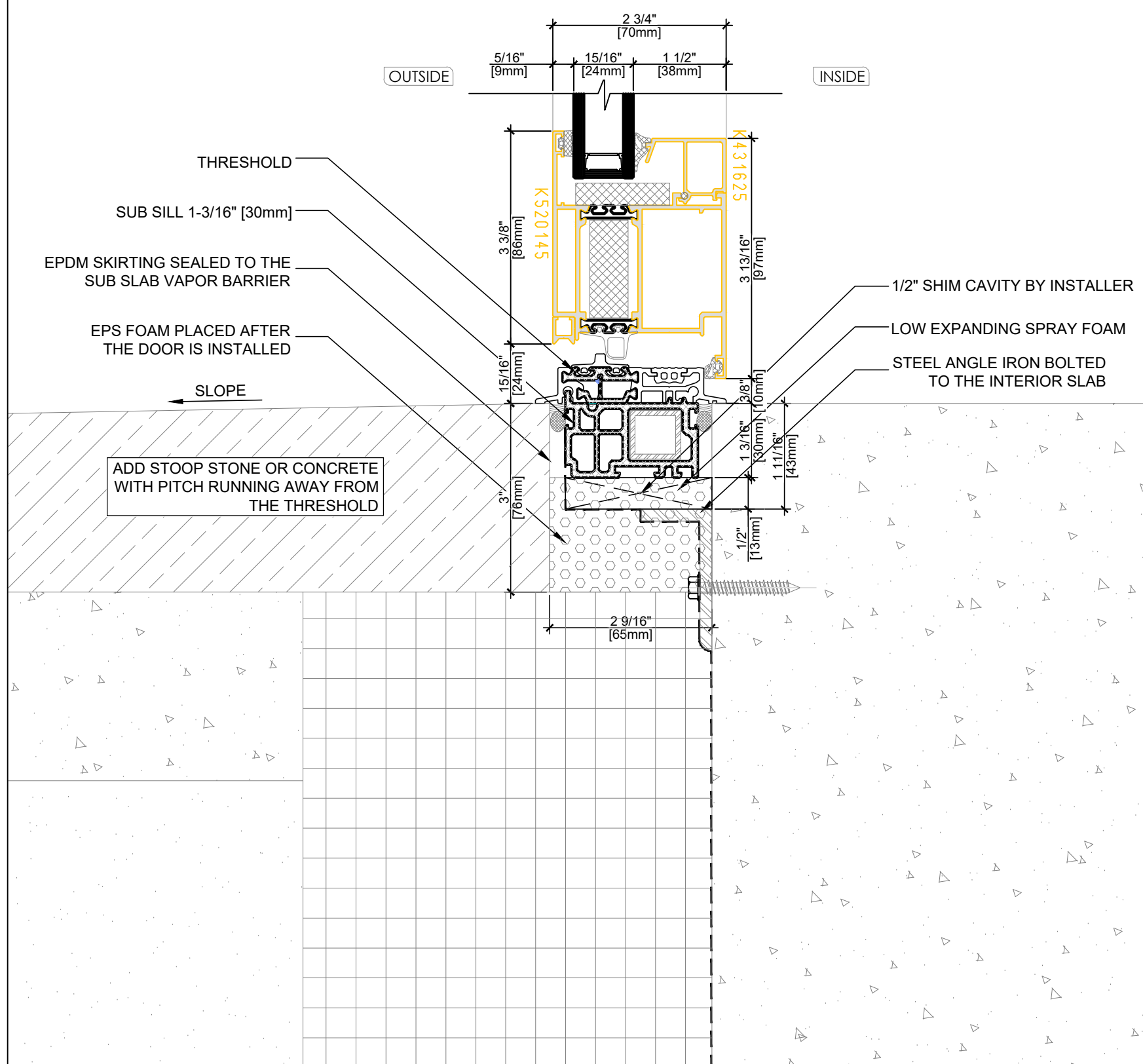

2B Option B:
ENTRY DOOR SILL DETAIL
DG-ALU79 -2 SCALE: 1:2

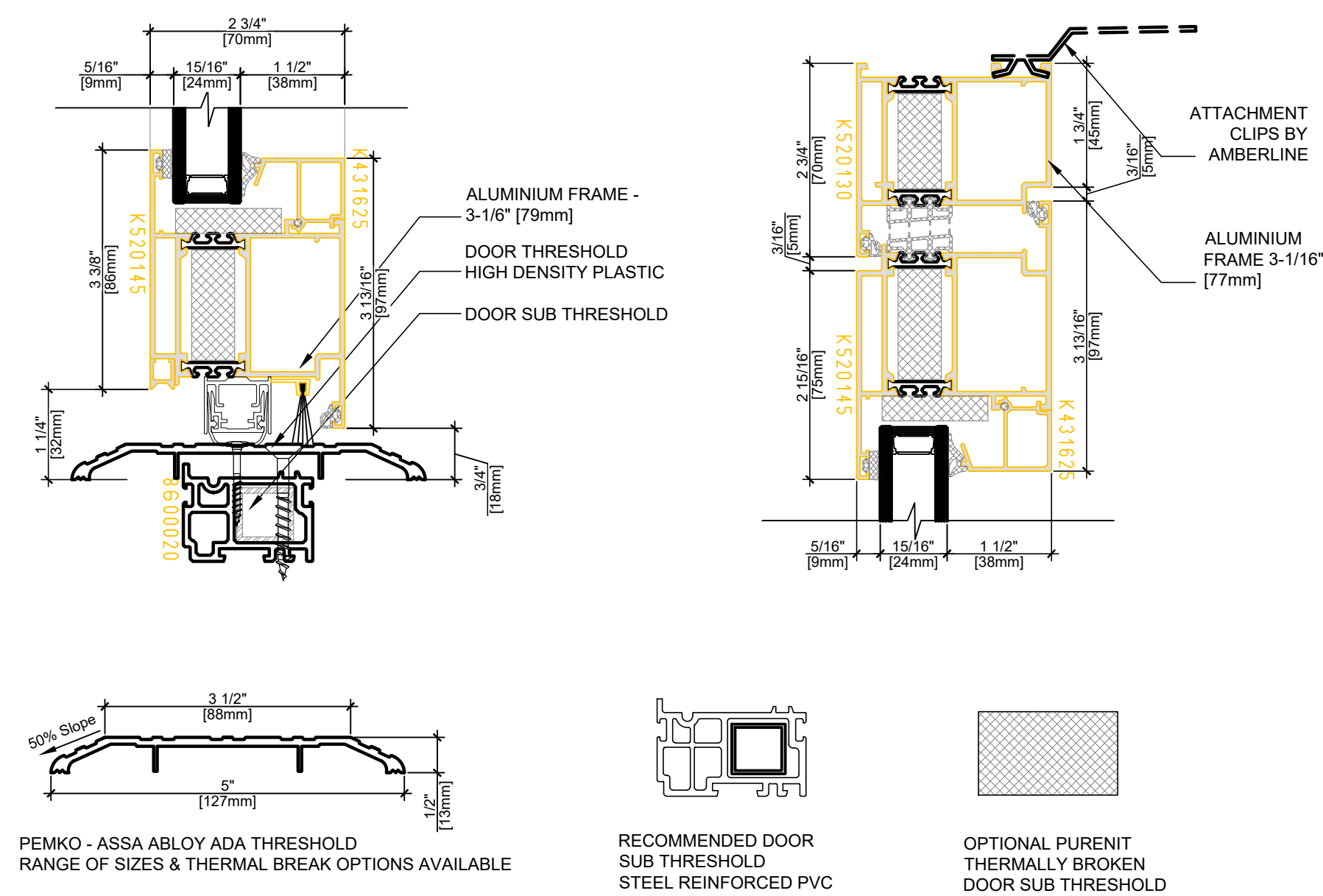

4 PROVIDED BY AMBERLINE
DG-ALU79 -2 SCALE: 1:2

AMBERLINE
HIGH PERFORMANCE WINDOWS AND DOORS

Notes:

Detail Type: Design Guide

Drawing Title: ALU 79_ADA Door_Concrete

Date: 07/24/24

Drawn By: RP

Scale: 1:2

Drawing No: DG-ALU79 -2

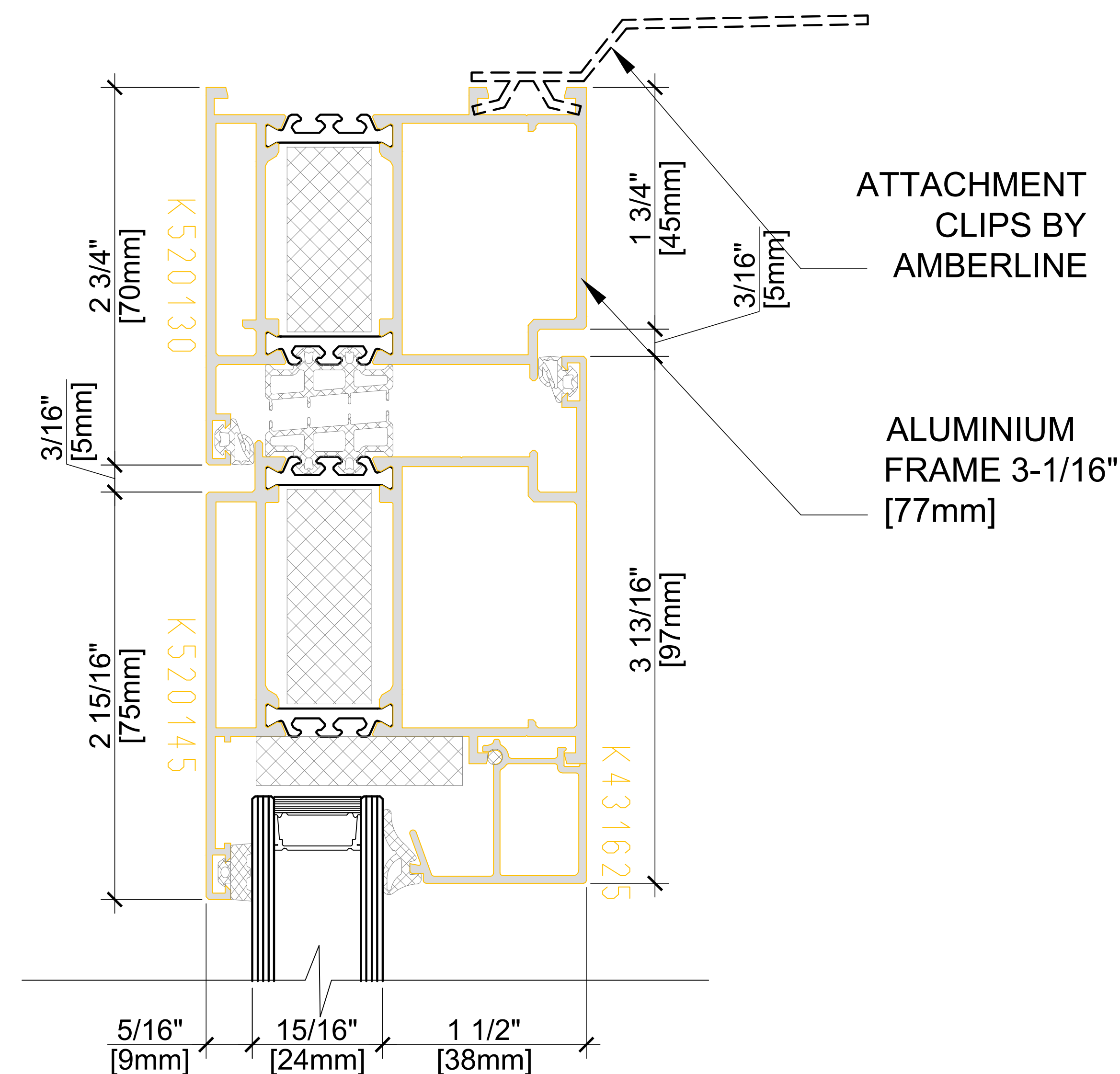
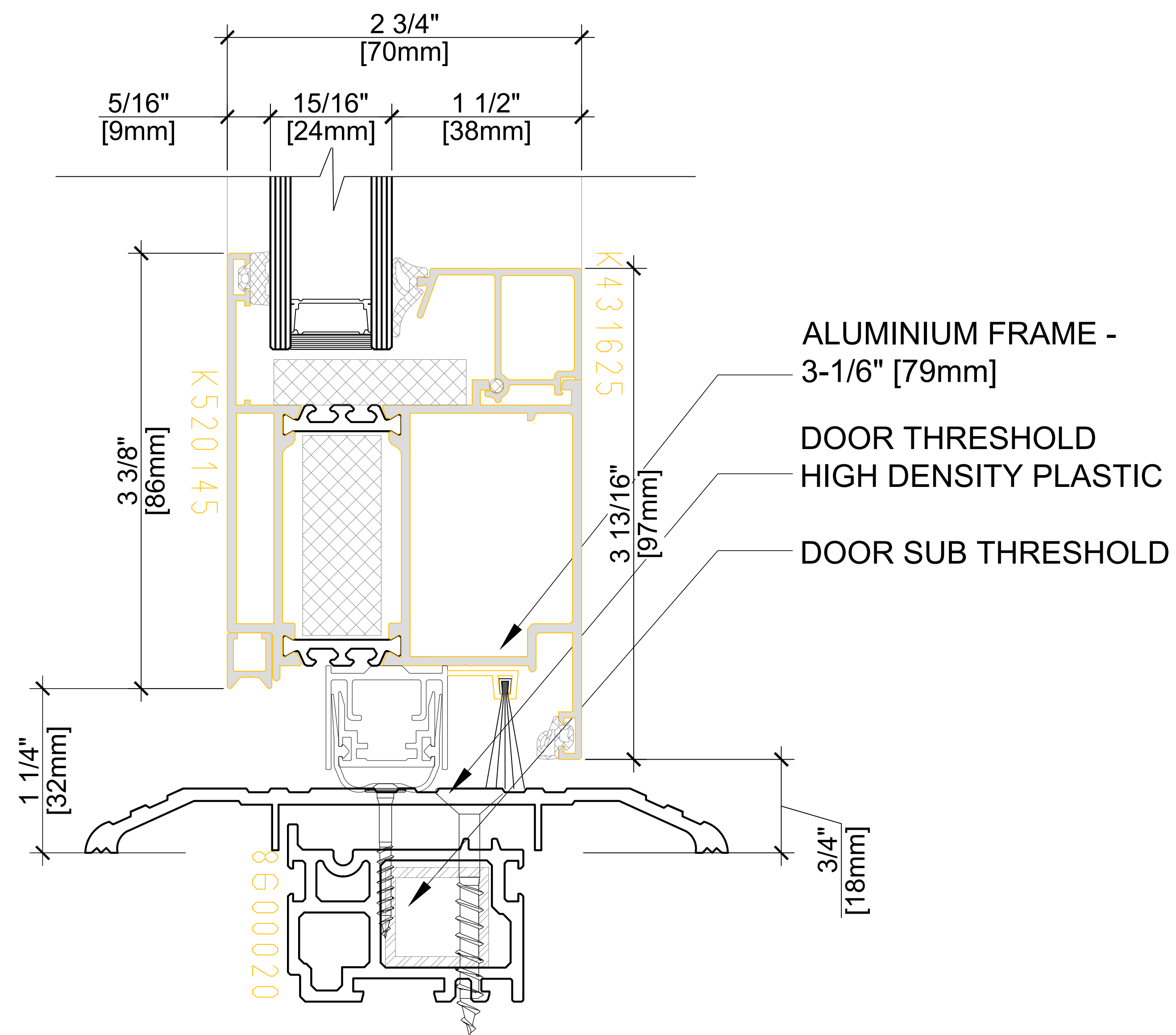

Elevation key:

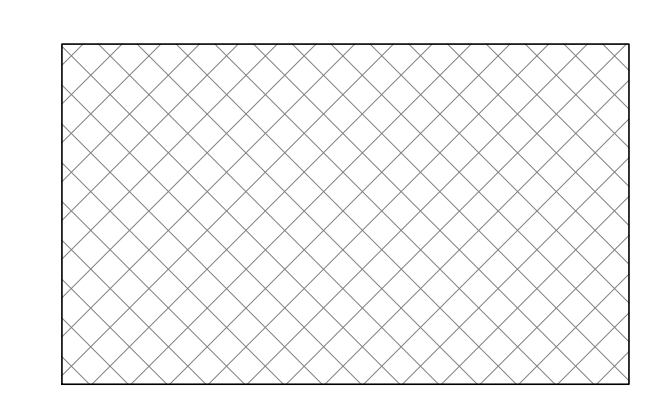
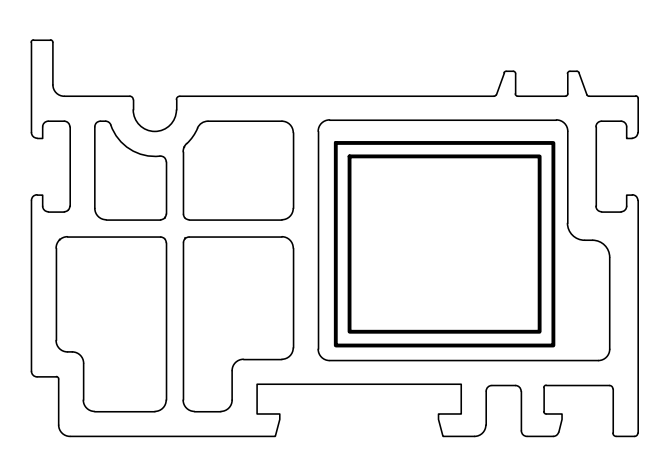
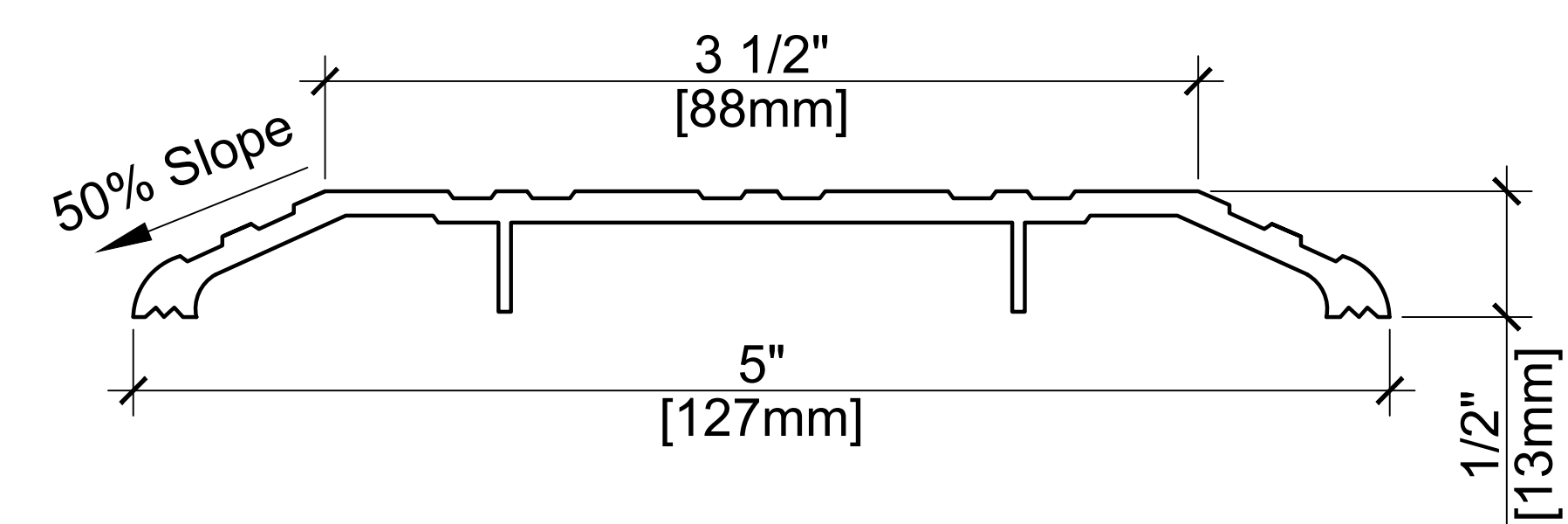
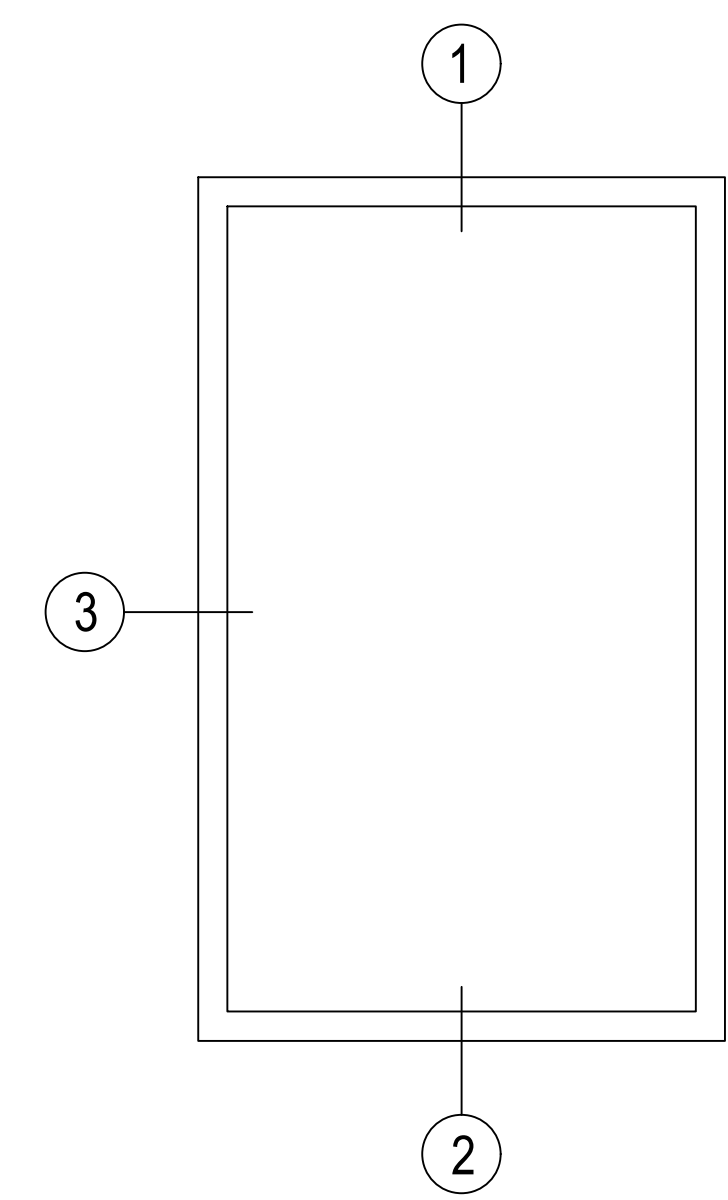

PEMKO - ASSA ABLOY ADA THRESHOLD
RANGE OF SIZES & THERMAL BREAK OPTIONS AVAILABLE

RECOMMENDED DOOR
SUB THRESHOLD
STEEL REINFORCED PVC

OPTIONAL PURENIT
THERMALLY BROKEN
DOOR SUB THRESHOLD

A M B E R L I N E
HIGH PERFORMANCE WINDOWS AND DOORS

Notes:

Detail Type : Desgin Guide	
Drawing Title : ALU 79_ADA Door_Concrete	
Date : 07/24/24	
Drawn By : RP	Scale : 1.5 : 1
Drawing No : DG-ALU79-3	